

# Using a Tester to Accurately Predict Hang-Up Issues In Process Equipment

Authors: Max Groom\* and Dr. Kerry Johanson\*\*

\* Particulate Systems (a subsidiary of Micromeritics) \*\* Material Flow Equipment, LLC

## Full Abstract

Unconfined yield strength, measured as a function of major principle stress, is responsible for most process arches and hang-ups. However, traditional measurements of cohesive flow properties often result in poor process predictions, especially in small diameter hoppers. The major principle stress in a hopper is directly proportional to the hopper span. Thus, stress levels near small hopper outlets are very small – so small that traditional measurement techniques cannot quantify the bulk unconfined yield strength at stress levels corresponding to those expected near the hopper outlet. We postulated that the inability to predict this process behavior in small bins is because most current methods cannot measure strength values at low enough stresses to be useful. Recent advances in technology allow measurement of unconfined yield strength of fine powders at very low stress levels. To prove the technology, bulk strength values were measured using both traditional methods and the new methodology. Critical arching dimensions were computed using data from both methods and compared to direct measurements of arches in small diameter hoppers. Traditional measurement required data extrapolation to predict arching in small hoppers and resulted in arching estimates two or three times those measured in actual hoppers. Conversely, using the new method to compute critical arching dimensions resulted in predictions within 20% of actual measured arching dimensions. Thus, this new technology and test method provide prediction of process behavior significantly superior to all previous methods.

## Unconfined Yield Strength Measured by Traditional Methods

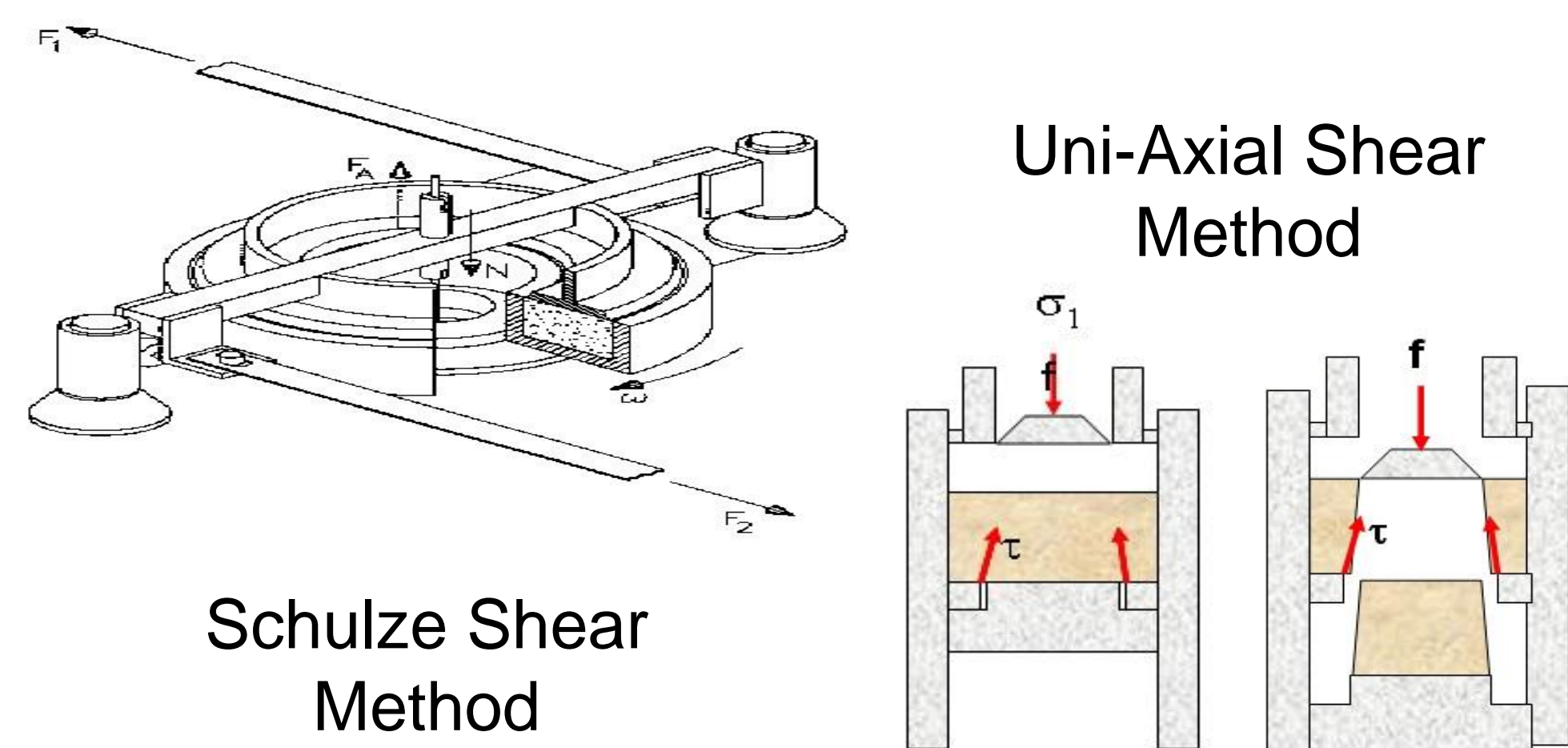

There are several apparatus and methodologies available to measure material bulk strength. Most involve placing a material sample into a test cell, adding compaction pressure and rotating (or shearing) the apparatus until the material fails (falls out of the test cell):

- Most bulk strength testers based on material shear require multiple tests to garner a single data point
- Most bulk strength testers require 300 or more grams of material to produce a full flow function
- Most bulk strength testers can measure only at pressures near or above 1KPa
- Real process pressures are more on the order of 300-400 Pa
- Extrapolation is messy – and does not correlate to small-scale geometries
- Small-scale designs based on traditional strength test methods

## Recent advances in technology allow measurement of unconfined yield strength of fine powders at very low stress levels

### Measurement Methodology

The test technique is to place a small quantity of material into an enclosed conical cavity; consolidate it using centrifugal force; remove the obstructions at the bottom of the conical cavity and use centrifugal force to cause material to fail, yield or extrude from the cavity. The process is summarized in steps 1 through 4 pictured below.

#### Step 1

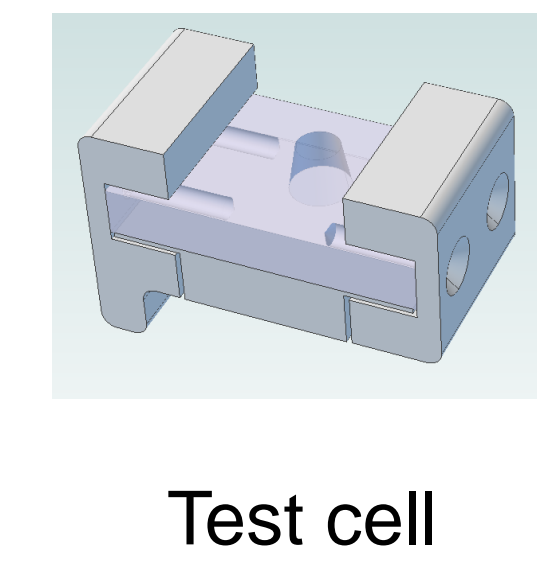
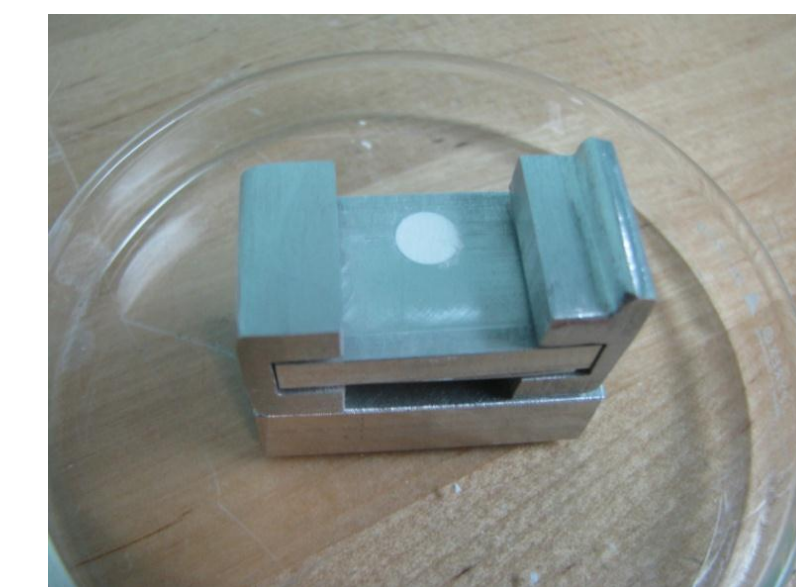

Test cell

- Fill test cell with material: less than one (1) gram required

#### Step 2

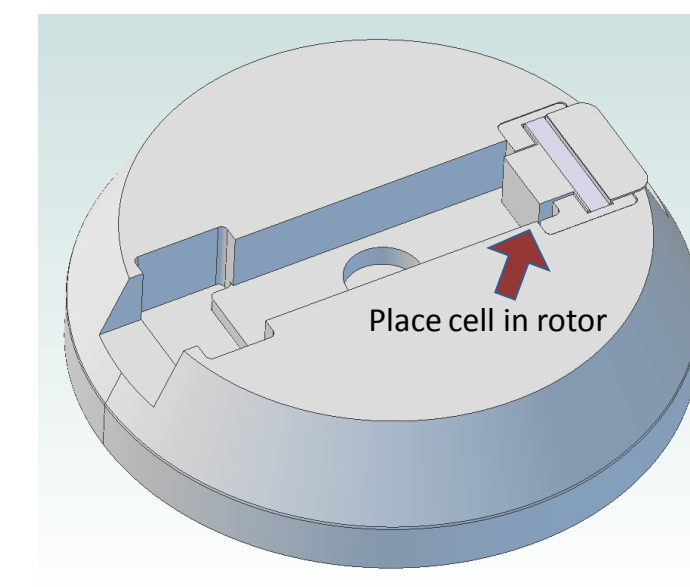

- Place test cell in rotor holder
- Centrifugal force used to both consolidate and fail material

#### Step 3

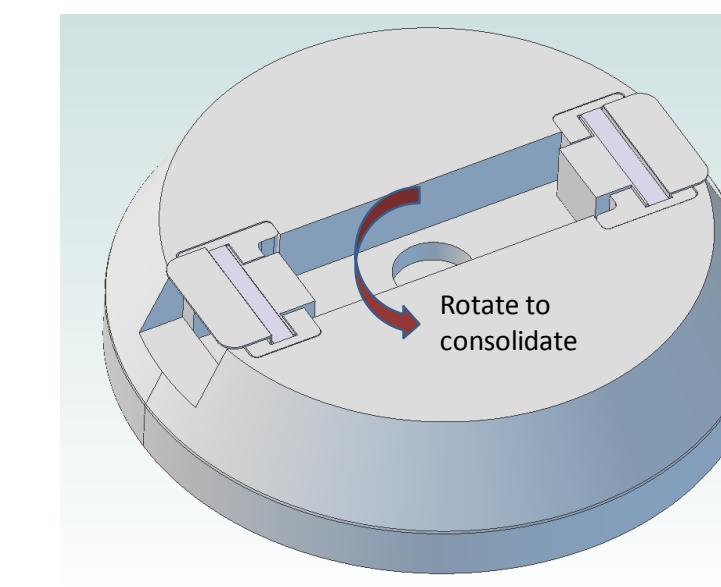
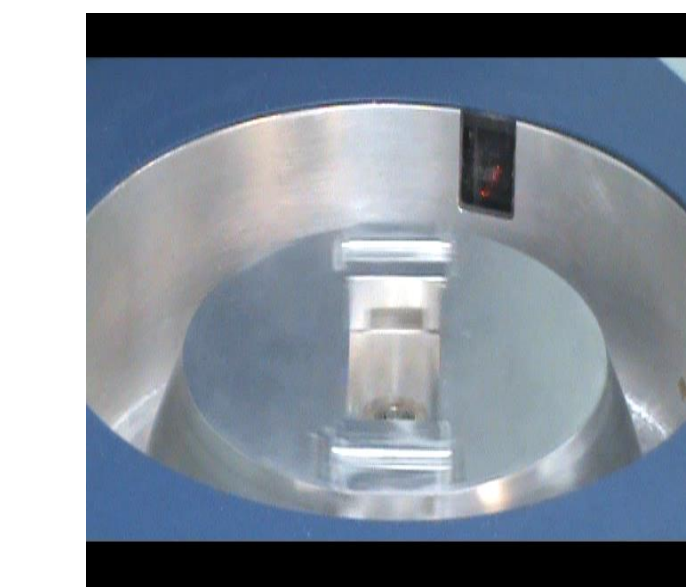

- Place full cell in rotor
- Spin rotor to compact material in cell
- Compute the major principle stress

#### Step 4

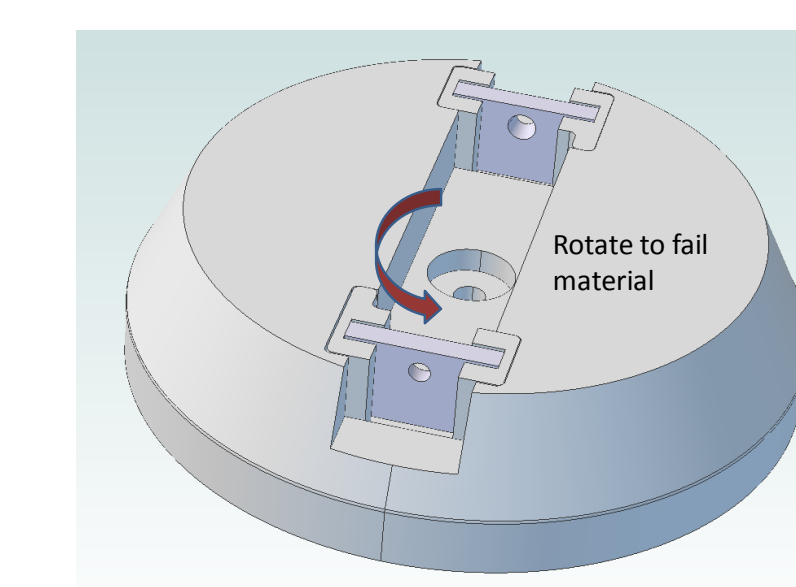
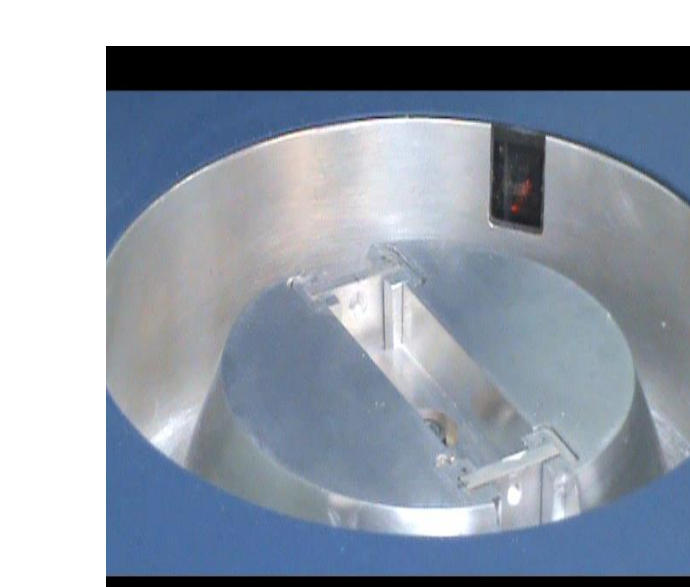

- Remove retaining gates
- Spin rotor to drive material from cell
- Laser detects free path
- Compute unconfined yield strength

## Case Study – Comparison of New Method with Schulze Shear Method

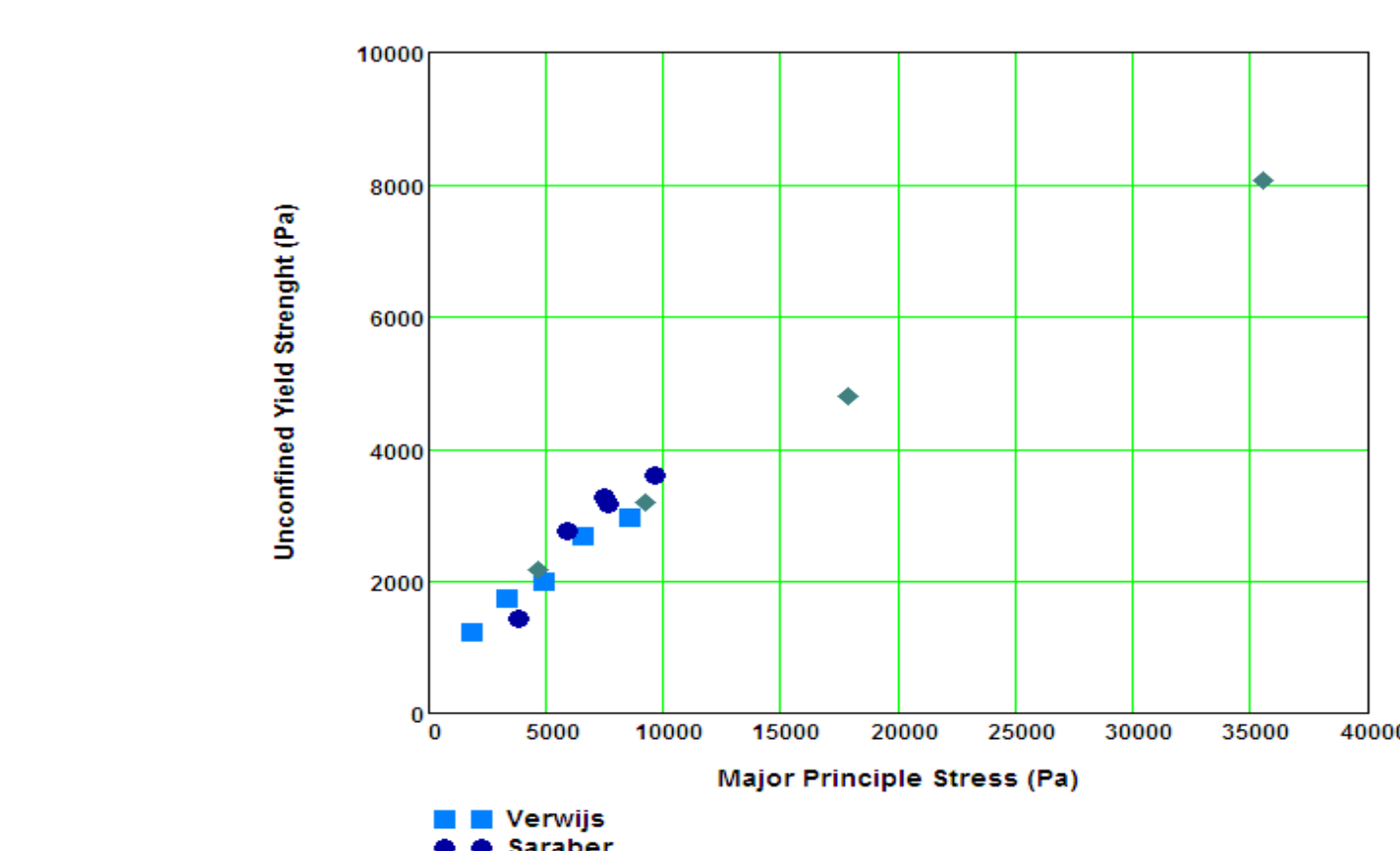

Figure 1. Comparison of BCR Limestone data generated from three different studies

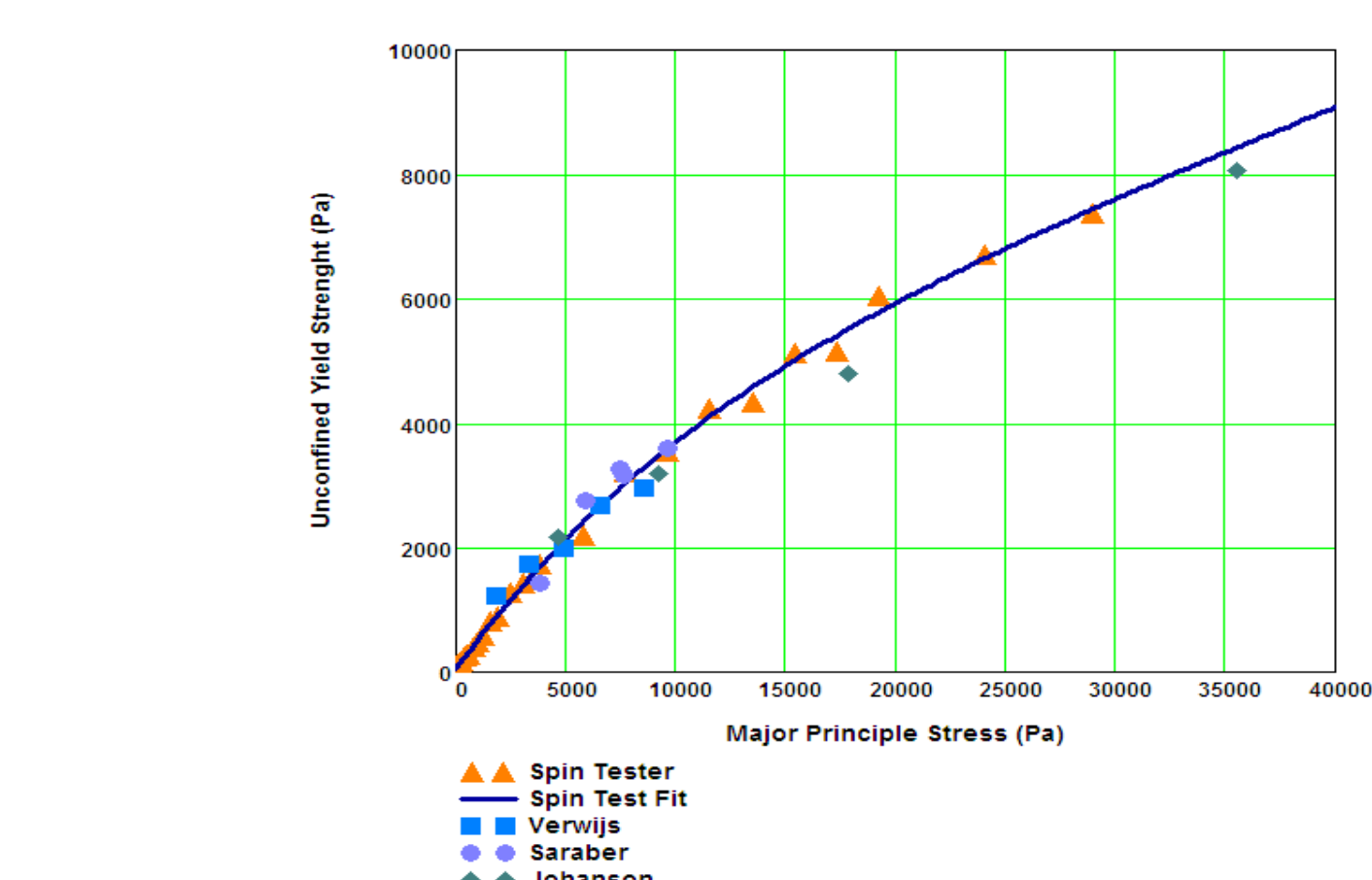

Figure 2. Comparison of BCR limestone data generated from three different studies and new test technique (SSSpinTester)

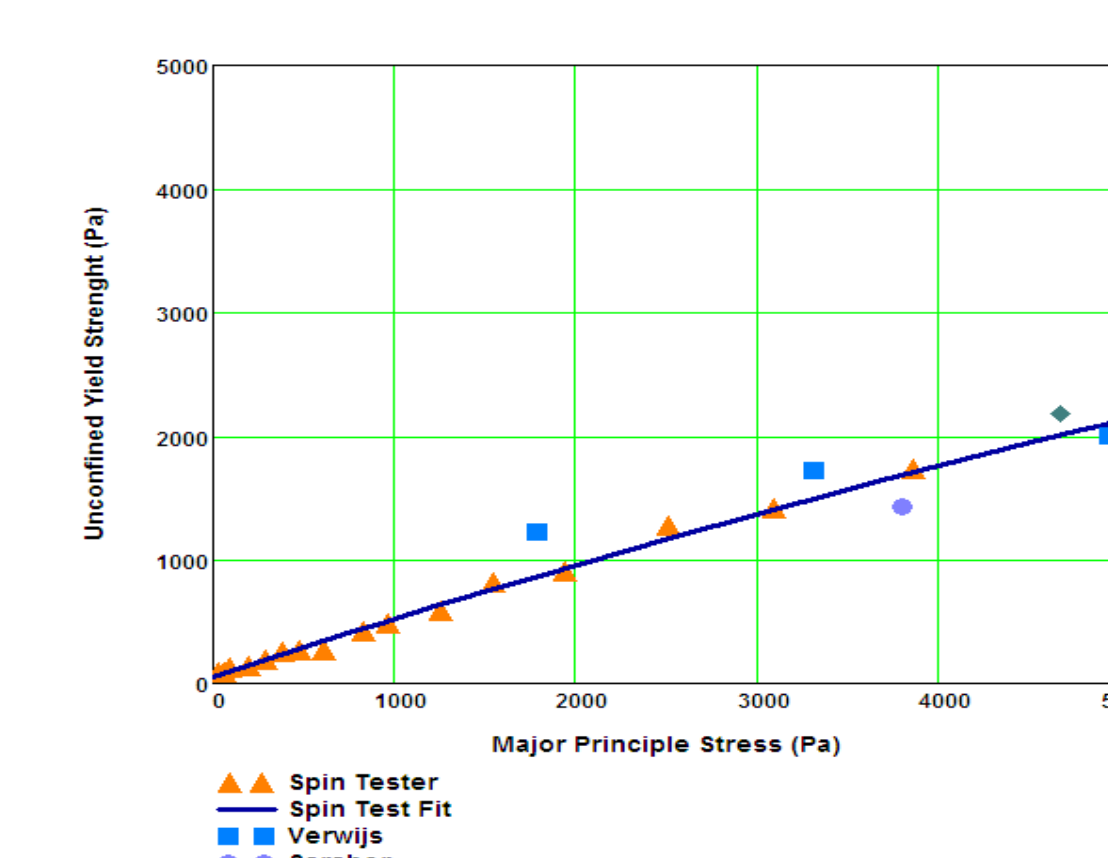

Figure 3. Comparison of low stress level BCR limestone data generated from three different studies and new test technique (SSSpinTester)

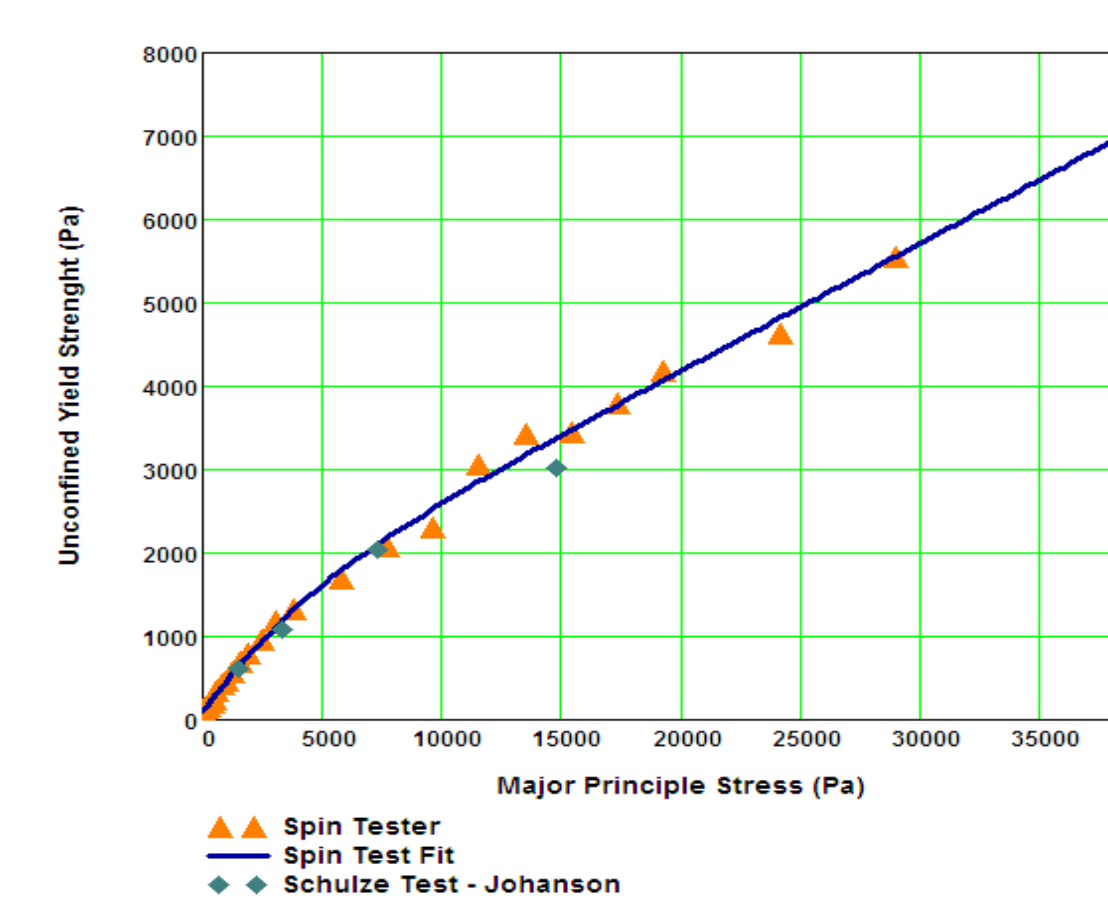

Figure 4. Comparison of the unconfined yield strength of Argo cornstarch measured with the Schulze direct shear method and the new test technique (SSSpinTester)

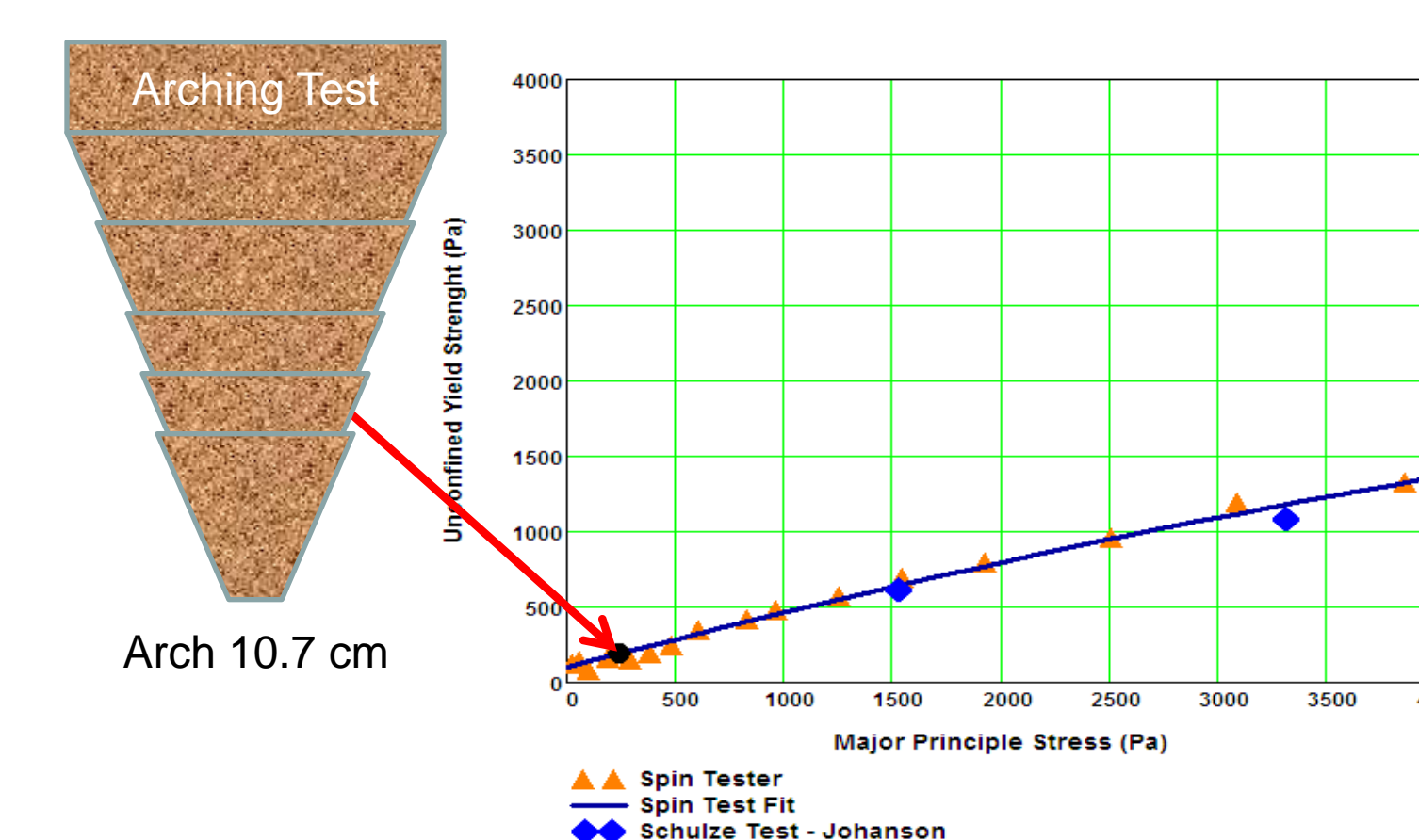

Figure 5. Comparison of the lower stress level unconfined yield strength of Argo corn starch measured with the Schulze direct shear method and the new test technique (SSSpinTester)

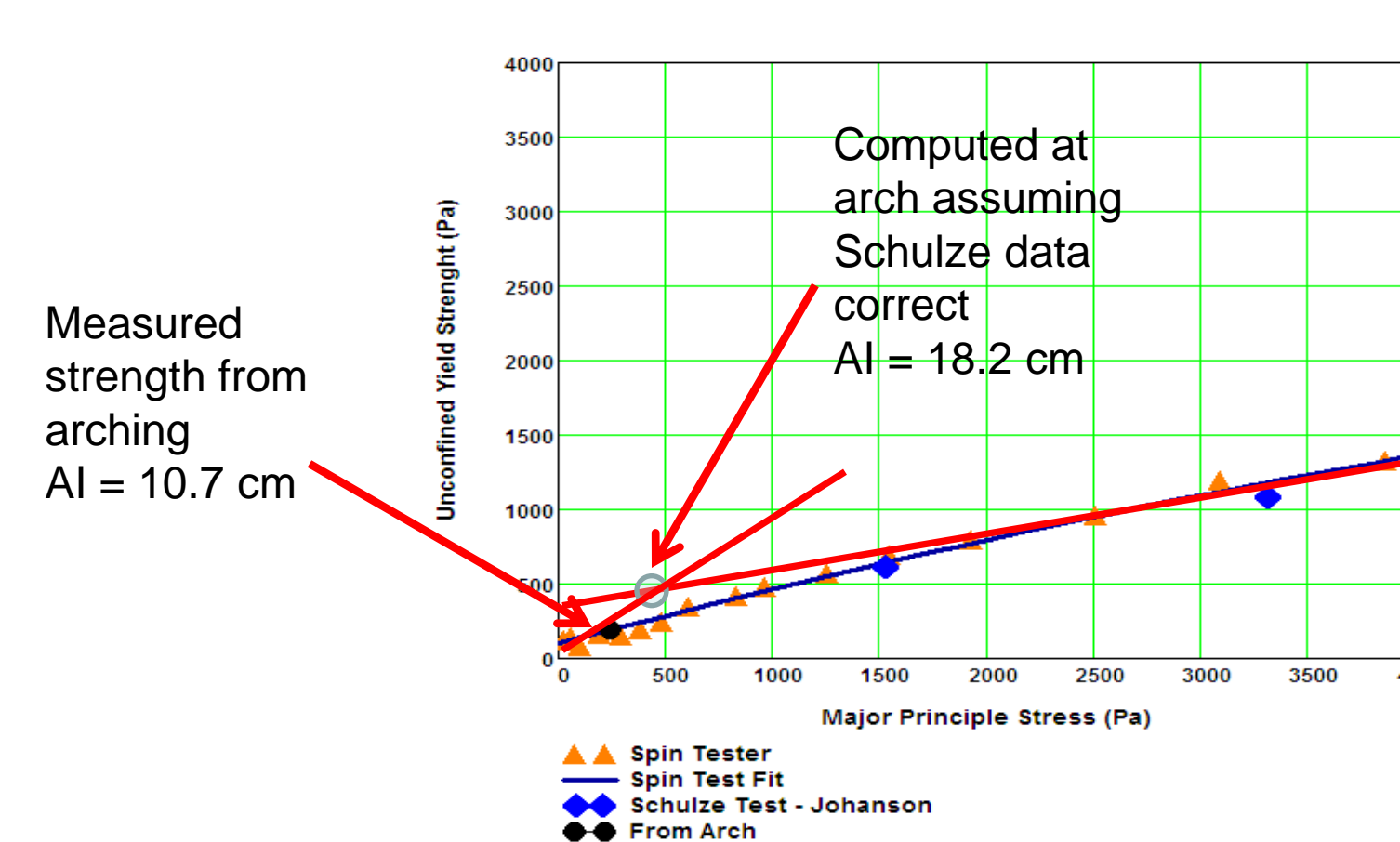

Figure 5. Comparison of the lower stress level unconfined yield strength of Argo corn starch measured with the Schulze direct shear method and the new test technique (SSSpinTester)

## Conclusions

- New test method can measure strength at low stress values comparable to those near small diameters hopper outlets
- Can interpolate to get arching instead of extrapolate
- Strength is measured with very little material: Good for expensive and hard to get materials
- Low pressure strength can be applied to segregation on piles, capsule filling, tablet feed, fluidization, dispersion models and other low pressure unit operations or formulation needs

